

M30

M30 MULTI-PURPOSE KITCHEN MACHINE



■
150 + servings
per day

■
Gastronomy

■
Hotels

■
Boarding houses

■
Canteens

■
Hospitals



Cutting hopper with double safety switch off



Easy-to-use coupling system for change of attachments



Digital keypad with timer, LED indicator, two speeds and overload protection



Cabinet unit in stainless steel, mobile, with compartment for Gastro-Norm container. Additional designs available on request.

- Modular building concept, easy to use
- Multi-purpose use: Chopping, shredding, grating, straining, pureeing, stirring, beating, kneading, cutting, steaming, tenderizing
- All parts made of stainless steel
- Accessories HACCP compliant
- Safety switch-off with coded magnet

SELECTION OF ACCESSORIES



Universal basic unit,
stainless steel
549 000 3120*

Safety switch-off in accordance
with EU standard



Cutting hopper,
stainless steel
566 000 0760*



Curved blade discs, stain-
less steel, adjustable
0-5 mm 130 020 000*
0-10 mm 130 021 000
Curved blade disc,
stainless steel
4 mm 553 000 0388

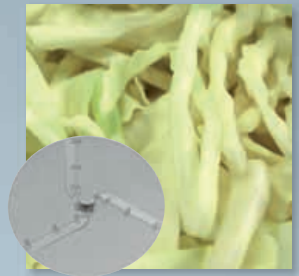

Cabbage blade discs,
stainless steel
1.3 mm 130 023 000
2.5 mm 130 024 000



Strip cutting discs,
stainless steel, Juliennes
2 mm 565 000 0362
3 mm 565 000 0363
4 mm 565 000 0364
5 mm 130 038 000
7 mm 130 039 000*
10 mm 130 040 100

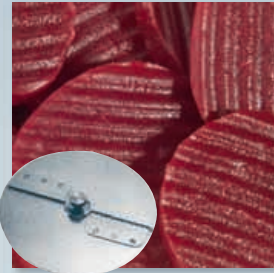

Crinkle cut blade disc,
stainless steel,
adjustable
2-7 mm, 549 000 3703

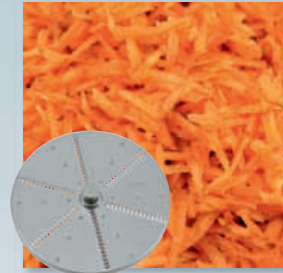

Raw vegetable disc,
sharpened separately
3 mm 565 100 0373
Shredding discs,
sharpened separately
6 mm 565 100 0376
9 mm 565 100 0377



Grating discs
2 mm 565 100 0371
3 mm 565 100 0372
Cheese grating discs,
sharpened separately
3 mm 553 100 0373
6 mm 553 100 0374



Cylinder hopper, stainless
steel 566 000 0725*
Wing, stainless steel,
for cylinders 331-337,
326, 328
553 100 0330*

Stainless steel, HACCP,
capacity + min . 20%



Raw vegetable cylinders
stainless steel, sharpened
separately
2 mm 130 070 337
3 mm 130 070 336*
4 mm 130 070 326

Stainless steel, HACCP,
capacity + min . 20%



Shredding cylinders,
stainless steel,
sharpened separately
6 mm 130 070 334*
9 mm 130 070 335

Stainless steel, HACCP,
capacity + min . 20%



Grating cylinders,
stainless steel
3 mm 130 070 332*
4 mm 130 070 331

Stainless steel, HACCP,
capacity + min . 20%



Potato grating cylinder,
stainless steel,
crown toothed
2 mm 130 070 333

Stainless steel, HACCP,
capacity + min . 20%



Potato pancake cylinder,
stainless steel, partly
crown-toothed, combina-
tion of 333/337
130 070 328

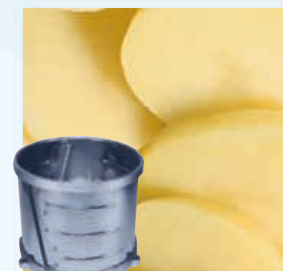

Strip cutting cylinder
1,5 mm 553 000 0338
Wing for cylinder 338
553 000 0330

CUTTING DISCS AND ACCESSORIES



Universal hopper,
stainless steel
566 000 0720
Straining wing for
cylinders 100, 200, 300,
345 130 076 005

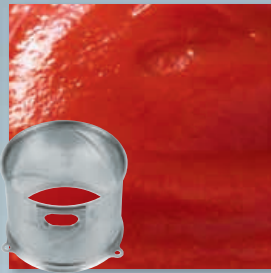

Straining cylinders
stainless steel
1.5 mm 130 072 100
3 mm 130 072 200
Straining plate for
cylinders 100, 200, 345
553 000 0342

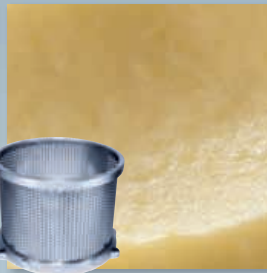

Pureeing cylinder
stainless steel
130 072 300
Micro-fine grating
cylinder, stainless steel
2 mm 553 000 0345



Dual-chamber hopper,
stainless steel
566 000 0780*



Crescent blade discs,
stainless steel
3 mm 565 000 0383
4 mm 565 000 0384*
6 mm 565 000 0386



Dicer, complete,
stainless steel
(* only Export)
8 mm 549 000 0392
11 mm 549 000 0394*
16 mm** 549 000 0393
22 mm** 549 000 0396

Safety switch-off in accordance
with EU standard



Planetary stirring, beating
and kneading unit 20 l
566 100 0201*



Stirring whisk,
stainless steel
4 mm 15 00 897
5 mm 15 00 898



Beating whisk,
stainless steel
15 00 896



Kneader, stainless steel
552 000 1275



Meat and vegetable
mincer, 82 mm with
coded whole plates
130 049 000*
Composed of: mincer
housing, worm, 5-part
cutting set made of stainless
steel, L & W, spacer ring,
meat tray and pusher.



Universal housing for
strip cutter, steaker and
meat tenderizer
130 025 100
Composed of: stainless steel
housing and coupling M 30.
Attention: To be ordered
together with strip cutter set
and/or tenderizer/steaker
set.

Safety switch-off in accordance
with EU standard



Strip cutter set
130 026 100
Composed of: lid complete
incl. funnel, magnet holder
and pusher.
Attention: universal housing
as well as the resp. inserts are
not included in the delivery.
Cutting inserts,
stainless steel
3.3 mm 15 00 727
5.0 mm 15 00 728
6.6 mm 15 00 729
9.9 mm 15 00 730
19.8 mm 15 00 731

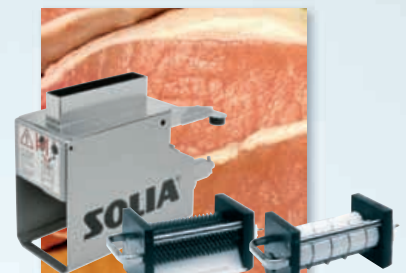

Steaker/meat tenderizer
set
130 027 100
Composed of: feed cute and
magnet holder.
Attention: universal housing
as well as the resp. inserts are
not included in the delivery.
Steaker insert
15 00 732
Meat tenderizer insert
15 00 733

TECHNICAL DATA

Power supply	400 V, 50 Hz, 2.5 m cable with CEE plug
Output (kW)	1.4/1.8
Fuse protection (A)	16
Ingress protection	IP 54 (splash-proofed)
Infinitely variable speed control (rpm)	160/320
Dimensions (L x W x H)	280 x 650 x 320 mm
Weight (kg)	49



Basic unit with accessoires meat mincer and trolley

Basic unit with accessoires planetary stirring, beating and kneading unit and trolley

Delivery standard: Basic unit without accessoires. Trolley optional

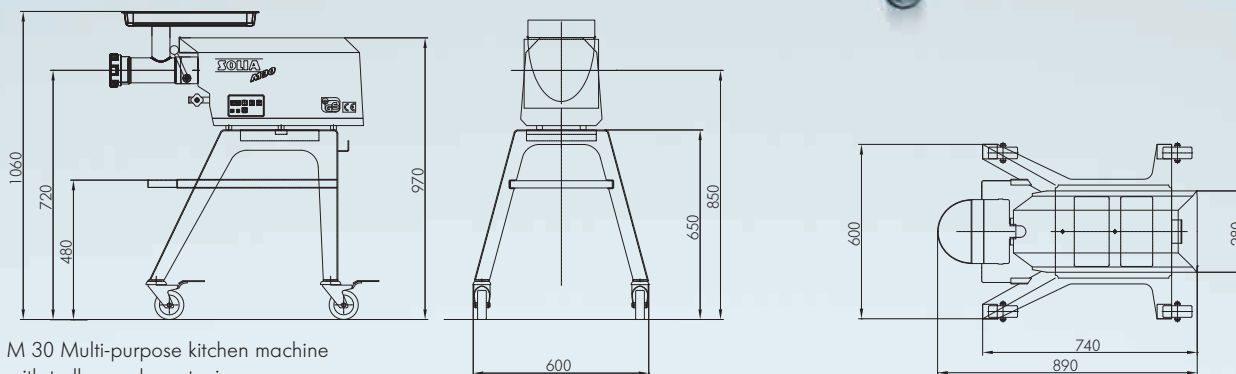

M 30 Multi-purpose kitchen machine with trolley and meat mincer

PROCESSING CAPACITY

Description	Use	Throughput**
Raw vegetables cylinders	Raw of eg. potatoes, celery, carrots	600-1000 kg/h
Shredding cylinders	Shredding of eg. radishes, carrots	1100-1200 kg/h
Grating cylinders	Grating of eg. hard bread, boiled potatoes, nuts, chocolate, almonds	600-900 kg/h
Potato grating cylinder	Grating of raw potatoes for dumplings	500 kg/h
Potato pancake cylinder	Grating of raw potatoes	800 kg/h
Dicer	Dicing of eg. vegetables, potatoes, celery, carrots	300-780 kg/h

** The throughputs are dependent on cutting thickness and product.

The figures shown here are for illustration only and may deviate from the actual design version. Technical alterations are reserved. For additional accessories please refer to our price list.

*Items marked with an asterisk are part of the basic equipment.